



Investigative Energy Audit
For
Tyonek Clinic



Prepared For
Native Village of Tyonek

August 30, 2017

Prepared By: Kevin Ulrich & Kelli Whelan

**ANTHC-DEHE
4500 Diplomacy Drive
Anchorage, AK 99508**

Table of Contents

PREFACE	2
ACKNOWLEDGMENTS.....	2
OVERVIEW.....	3
ENERGY BASELINE	3
PROPOSED ENERGY EFFICIENCY MEASURES (EEM).....	3
FACILITY DESCRIPTION	4
PROJECT FINANCING.....	6
MEASUREMENT AND VERIFICATION	7
Appendix A –Energy Billing Data.....	8
Appendix B – Energy Audit Report – Project Summary.....	9
Appendix C – Actual Fuel Use versus Modeled Fuel Use.....	10
Appendix D - EUI Calculation Details	11
Appendix E – Materials List and Labor Estimation.....	12
Appendix F – Materials Specifications	13

PREFACE

The purpose of this report is to provide guidance in reducing facility operating costs and enhance the sustainability of this community. The report assesses the current energy usage of the facility, provide options for reducing the amount of energy used, and evaluate the cost vs. benefit of each option.

Discussions of site specific concerns, financing options, general facility information, and an Energy Efficiency Action Plan are also included in this report.

ACKNOWLEDGMENTS

The ANTHC Rural Energy Initiative gratefully acknowledges the assistance of President Arthur Standifer, Tribal Administrator Sandi Kroto, and Tyonek Native Corporation Administrator Tonya Kaloa.

OVERVIEW

This report was prepared for the Native Village of Tyonek. The scope of the audit focused on the Tyonek Clinic and includes an analysis of building occupancy schedules, building shell, heating systems, heating and ventilations systems, domestic hot water, lighting, and other electrical loads. The Tyonek Clinic is approximately 5,264 sq. ft. in area split over two floors and it serves as the central healthcare facility for the residents of the community. The building is currently occupied by both the Native Village of Tyonek as well as the Southcentral Foundation.

Annual Energy Costs by Fuel Type

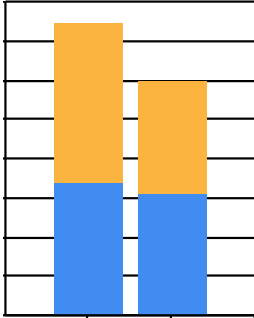

ENERGY BASELINE

Based on electricity and fuel oil prices in effect at the time of the audit, the total predicted energy costs are \$14,844 per year. This includes \$6,743 for electricity and \$8,101 for #1 fuel oil.

Table 1 lists the predicted annual energy usage before and after the proposed retrofits for the Tyonek Clinic.

Table 1: Predicted Annual Energy Use for the Tyonek Clinic

Predicted Annual Fuel Use				
Fuel Use	Existing Building	With Proposed Retrofits	Total Energy Savings	Total Cost Savings
Electricity	46,402 kWh	42,451 kWh	3,951 kWh	\$632
#1 Oil	1,706 gallons	1,212 gallons	494 gallons	\$2,347

PROPOSED ENERGY EFFICIENCY MEASURES (EEM)

Table 2 below summarizes the energy efficiency measures analyzed for the Tyonek Clinic. Listed are the estimates of the annual savings, installed costs, and two different financial measures of investment return. All costs assume that local labor will be used with no additional cost associated for travel or administrative tasks.

Table 2: Priority List – Energy Efficiency Measures

Priority	Feature	Improvement Description	Annual Energy Savings	Installed Cost	Savings to Investment Ratio, SIR ¹	Simple Payback (Years) ²	CO ₂ Savings
High	Setback Thermostat: Top Floor	Install new programmable thermostats and implement an unoccupied setback of 60 deg. F.	\$1,278	\$7,000	2.48	5.5	5,697.5
High	Setback Thermostat: Bottom Floor	Install new programmable thermostats and implement an unoccupied setback of 60 deg. F.	\$1,127	\$6,500	2.35	5.8	5,022.6
Medium	Boilers	Clean and Tune Boilers	\$196	\$2,500	1.36	12.8	872.7

Priority	Feature	Improvement Description	Annual Energy Savings	Installed Cost	Savings to Investment Ratio, SIR ¹	Simple Payback (Years) ²	CO ₂ Savings
Medium	Other Electrical: Coffee Makers (7)	Unplug coffee makers in the evenings when not in use.	\$62	\$350	1.30	5.6	1,026.3
Medium	Other Electrical: Desktop Computers - Lower Floor	Shut off computers during the evenings when not in use.	\$16	\$100	1.05	6.4	264.6
Low	Lighting: Upper Floor T12	Replace with new, direct-wire LED equivalent lamps.	\$7	\$60	0.97	8.6	54.2
Low	Other Electrical: Desktop Computers - Upper Floor	Shut off computers during the evenings when not in use.	\$11	\$100	0.76	8.8	193.1
Low	Lighting: Upper Floor 4ft. T8	Replace with new, direct-wire LED equivalent lamps.	\$37	\$600	0.52	16.1	290.4
Low	Lighting: Lower Floor T8 4ft. 32W	Replace with new, direct-wire LED equivalent lamps.	\$22	\$360	0.52	16.1	174.2
Low	Lighting: Upper Floor 2ft. T8	Replace with new, direct-wire LED equivalent lamps.	\$7	\$240	0.26	32.3	58.1
Low	Lighting: Upper Floor Sylvania T8 28W	Replace with new, direct-wire LED equivalent lamps.	\$66	\$2,400	0.23	36.3	515.5
Low	Lighting: Lower Floor Sylvania T8 28W	Replace with new, direct-wire LED equivalent lamps.	\$64	\$2,340	0.23	36.3	502.6
13	Refrigeration: Standing Freezer - Upper Break Room	Replace with smaller, more energy-efficient minifridge.	\$5	\$500	0.07	94.0	88.8
TOTAL			\$2,899	\$23,050	1.67	8.0	14,760.5

FACILITY DESCRIPTION

Building Occupancy Schedules

The building is occupied from 9:00AM to 4:00PM five days per week as standard operating hours with a one-hour break each day for lunch.

Building Shell

The building is a standard wood-framed structure with 2x6 lumber in the walls and roof. The upper floor of the building has an attic that spans the entire length and width of the facility. The building is built on a gravel pad foundation with the lower half of the building built into the side of a hill.

There are fifteen total windows in the building. Each window has double-pane glass with vinyl framing. Four of the windows are 34.75" x 46", four of the windows are 69.5" x 46", five of the windows are 104.25" x 46", one of the windows is 139" x 46", and one of the windows is 17.375" x 46".

There are five total entrances to the building. Four of the entrances are single insulated metal doors with one door having no glass and three doors having quarter-lite windows. These doors are approximately 3' x 6'8". The primary door in the upper floor is a single insulated metal door that is 4' x 6'8" with a quarter – lite window.

Heating Systems

The heating systems used in the building are:

Boiler 1

Fuel Type: #1 Oil
 Input Rating: 145,000 BTU/hr
 Steady State Efficiency: 80 %
 Idle Loss: 0.5 %
 Heat Distribution Type: Glycol
 Boiler Operation: All Year

Electric Infrared Heaters

Fuel Type: Electricity
 Input Rating: 0 BTU/hr
 Steady State Efficiency: 100 %
 Idle Loss: 0 %
 Heat Distribution Type: Air

Domestic Hot Water System

There is an Amtrol WHS-60 model hydronic hot water heater that is used for the restrooms, exam room sinks, and the clothes washer. The unit has approximately 60 gallons of storage.

Lighting

Table 3: Lighting Information in the Tyonek Clinic

Room	Bulb Type	Fixtures	Bulbs per Fixture	Annual Usage (kWh)
Exterior	LED Wall Pack	10	1	1,884
Upper Floor T8, 2ft.	Fluorescent T8, 2ft.	4	2	180
Upper Floor T8, 4ft.	Fluorescent T8 4ft. 32W	10	2	901
Upper Floor T12	Fluorescent T12 4ft. 40W	1	2	113
Upper Floor T8 Sylvania	Fluorescent T8 4ft. 28W	40	2	2,379
Lower Floor T8	Fluorescent T8 4ft. 32W	6	2	540
Lower Floor T8 Sylvania	Fluorescent T8 4ft. 28W	39	2	2,319

Occupancy sensors are present in nearly every room of the clinic and help to reduce the overall runtime of the lights during the clinic occupancy hours.

Electrical Equipment

Table 4: Major Electrical Equipment in the Tyonek Clinic

Equipment	Rating (Watts)	Annual Usage (kWh)
Standing Freezer – Upper Break Room	~ 47	408
Minifridge – Upper Break Room	~30	270
Refrigerator – Lower Floor Multipurpose Room	~50	438
Refrigerator (Sanyo) – Lower Floor Multipurpose Room	~38	330
Coffee Makers (7)	900 each	3,889
Microwave – Reception Room	1,100	100
Desktop Computers (3) – Upper Floor	280 each	1,617
Desktop Computers (5) – Lower Floor	230 each	2,214
Small Printer - Reception	75	7
Clothes Washer	2,400	877
Clothes Dryer	5,600	2,045
Microwave – Upper Break Room	1,200	110
Electric Burner – Upper Break Room	1,300	68
Centrifuge - Laboratory	184	34
Transistor/Ultrasonic Water Bath	150	27
Tuttnauer Autoclave Oven	1,344	245
Large Printer - Laboratory	583	103
AFHCAN Cart	1,200	376
Dental X-Ray Developer	575	90
Dental X-Ray Unit	1,380	216
Water Distiller	750	117
Dental Ultrasonic Cleaning System	500	78
Dental Sterilizer	1,725	270
Portable X-Ray Unit – Trauma Room	3,200	501
Trauma Room Computer	1,000	1,565
Oxygen Concentrator – Trauma Room	150	24
Small TV – Waiting Room	150	235
Box Fan	170	127
Microwave – Lower Kitchenette 2	1,100	100
Deep Fryer – Lower Kitchenette 2	1,800	188
Large Office Printer – Director’s Office	605	107

PROJECT FINANCING

The total estimated cost of the recommended EEM's \$23,050. The payback for the implemented EEM's is approximately 8.0 years. ANTHC is willing to assist the community with acquiring funds to complete the scope of work recommended in this energy audit.

There are several options for financing energy efficiency projects within the State of Alaska. These include the use of grants, loans, and other funding opportunities. Below is some information on potential funding opportunities.

Energy Efficiency Revolving Loan Program – This is a loan administered by the Alaska Housing Finance Corporation (AHFC) for use by any applicant who is also the owner of the building where the work will take place. It provides a loan for permanent energy-efficiency projects with a completion window of one year.

Sustainable Energy Transmission and Supply Program – This is a loan administered by the Alaska Energy Authority (AEA) for a government, business, or other organized body of people. It provides a loan for energy-efficiency or power transmission or distribution projects.

USDA-RD Communities Facilities Direct Loan & Grant Program - This is a loan or grant provided by the US Department of Agriculture – Rural Development (USDA-RD) for any essential community facility in a rural area. It provides a loan or grant to develop essential community facilities with upgrades or equipment for improvement.

MEASUREMENT AND VERIFICATION

The results of these recommended measures can be measured through the collection of energy use data through the monthly bills provided by the local electric utility and the local fuel oil supplier. Collecting data and performing a historical comparison is the simplest method of validating the energy and cost savings seen by the measures. Additionally, active remote monitoring systems are available that can collect and store data regarding energy and fuel usage. These systems allow the user to track the usage in real time and can be shared more easily with partners across the state.

APPENDICES

Appendix A –Energy Billing Data

The table below shows the fuel and electricity data used during the energy modeling process to confirm the accuracy of the energy distribution. Fuel records were not available for the clinic.

Month	Fuel Oil Use (gallons)	Electricity Use (kWh)
January	Not Available	4,543
February	Not Available	4,778
March	Not Available	4,294
April	Not Available	3,618
May	Not Available	2,788
June	Not Available	2,946
July	Not Available	3,145
August	Not Available	3,386
September	Not Available	3,462
October	Not Available	3,606
November	Not Available	3,864
December	Not Available	4,969

Appendix B – Energy Audit Report – Project Summary

ENERGY AUDIT REPORT – PROJECT SUMMARY	
General Project Information	
PROJECT INFORMATION	AUDITOR INFORMATION
Building: Tyonek Clinic	Auditor Company: ANTHC-DEHE
Address: P.O. Box 82009	Auditor Name: Kevin Ulrich and Kelli Whelan
City: Tyonek	Auditor Address: 4500 Diplomacy Drive
Client Name: Arthur Standifer	Anchorage, AK 99508
Client Address: P.O. Box 82009 Tyonek, AK 99682	Auditor Phone: (907) 729-3237
Client Phone: (907) 583-2111	Auditor FAX:
Client FAX:	Auditor Comment:
Design Data	
Building Area: 5,264 square feet	Design Space Heating Load: Design Loss at Space: 65,526 Btu/hour with Distribution Losses: 65,526 Btu/hour Plant Input Rating assuming 82.0% Plant Efficiency and 25% Safety Margin: 99,887 Btu/hour Note: Additional Capacity should be added for DHW and other plant loads, if served.
Typical Occupancy: 0 people	Design Indoor Temperature: 71.5 deg F (building average)
Actual City: Tyonek	Design Outdoor Temperature: -1.2 deg F
Weather/Fuel City: Tyonek	Heating Degree Days: 9,722 deg F-days
Utility Information	
Electric Utility: Chugach Electric	Average Annual Cost/kWh: \$0.16/kWh

Annual Energy Cost Estimate						
Description	Space Heating	Water Heating	Lighting	Refrigeration	Other Electrical	Total Cost
Existing Building	\$10,620	\$484	\$1,172	\$204	\$2,160	\$14,844
With Proposed Retrofits	\$8,267	\$487	\$968	\$184	\$1,836	\$11,945
Savings	\$2,353	-\$2	\$204	\$19	\$325	\$2,899

Building Benchmarks			
Description	EUI (kBtu/Sq.Ft.)	EUI/HDD (Btu/Sq.Ft./HDD)	ECI (\$/Sq.Ft.)
Existing Building	72.9	7.49	\$2.82
With Proposed Retrofits	57.9	5.96	\$2.27

EUI: Energy Use Intensity - The annual site energy consumption divided by the structure's conditioned area.
 EUI/HDD: Energy Use Intensity per Heating Degree Day.
 ECI: Energy Cost Index - The total annual cost of energy divided by the square footage of the conditioned space in the building.

Appendix C – Actual Fuel Use versus Modeled Fuel Use

The graphs below show the modeled energy usage results of the energy audit process compared to the actual energy usage report data. The model was completed using AkWarm modeling software. The orange bars show actual fuel use, and the blue bars are AkWarm’s prediction of fuel use.

Annual Energy Use

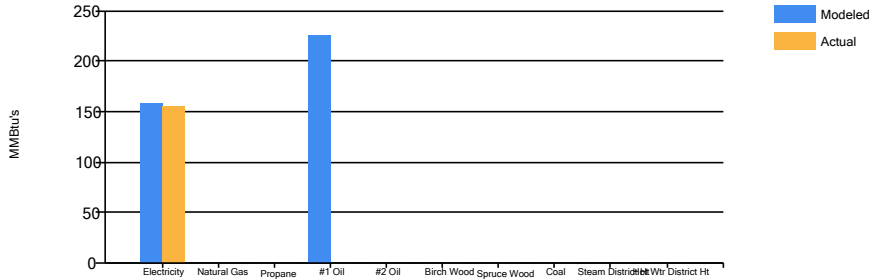

Electricity Use

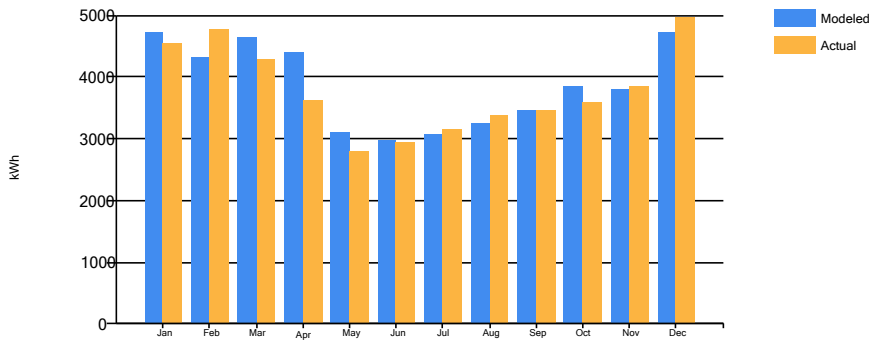

#1 Fuel Oil Use

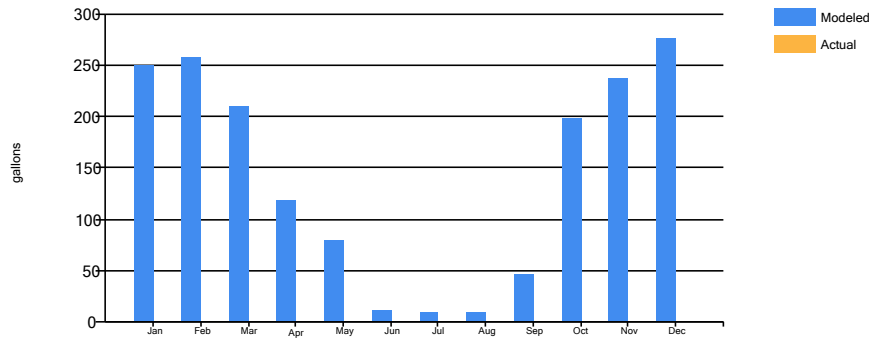

Appendix D - EUI Calculation Details

Electricity for the residential, commercial, and public facilities is provided by the Chugach Electric Association.

The average cost for each type of fuel used in this building is shown below in Table 5. This figure includes all surcharges, subsidies, and utility customer charges:

Table 5: Energy Cost Rates for each Fuel Type.

Average Energy Cost	
Description	Average Energy Cost
Electricity	\$ 0.16/kWh
#1 Oil	\$ 4.75/gallons

Table 6 shows the calculated results for the building Energy Use Index (EUI), which determines the total energy usage for a type of building for comparison with other buildings of the same type. This allows the user to determine the relative energy use of a building in relation to others of the same type or use.

Table 6: EUI Building Calculations for the Tyonek Clinic

Energy Type	Building Fuel Use per Year	Site Energy Use per Year, kBTU	Source/Site Ratio	Source Energy Use per Year, kBTU
Electricity	46,402 kWh	158,370	3.340	528,955
#1 Oil	1,706 gallons	225,133	1.010	227,384
Total		383,502		756,339
BUILDING AREA		5,264	Square Feet	
BUILDING SITE EUI		73	kBTU/Ft ² /Yr	
BUILDING SOURCE EUI		144	kBTU/Ft²/Yr	
* Site - Source Ratio data is provided by the Energy Star Performance Rating Methodology for Incorporating Source Energy Use document issued March 2011.				

Table 7 shows information on common energy use benchmarks used to characterize the efficiency of a building.

Table 7: Building Benchmarks for the Tyonek Clinic

Building Benchmarks			
Description	EUI (kBtu/Sq.Ft.)	EUI/HDD (Btu/Sq.Ft./HDD)	ECI (\$/Sq.Ft.)
Existing Building	72.9	7.49	\$2.82
With Proposed Retrofits	57.9	5.96	\$2.27
EUI: Energy Use Intensity - The annual site energy consumption divided by the structure's conditioned area. EUI/HDD: Energy Use Intensity per Heating Degree Day. ECI: Energy Cost Index - The total annual cost of energy divided by the square footage of the conditioned space in the building.			

Appendix E – Materials List and Labor Estimation

Table 8 & 9: Materials List and Cost Estimation for Tyonek Clinic EEM’s

Energy Retrofit	Required Materials	Quantity	Cost per Item	Total Materials Cost
Lighting	T8 4ft. LED equivalent lamps	200	\$15	\$3,000
Setback Thermostats	Thermostats	19	\$200	\$3,800
Clean and Tune Boilers	Boiler Guns, Controls	1	\$500	\$500
Replace Upper Break Room Refrigerator	Minifridge	1	\$250	\$250

Category	Cost (\$)
Labor	9,050
Travel	3,140
Materials	7,550
Freight	1,133
Indirect	2,087
Total	\$22,960

Appendix F – Materials Specifications

Robertshaw®

9701i2

DELUXE
PROGRAMMABLE
THERMOSTAT



GAS



ELECTRIC



OIL



HEAT PUMP

Menu Driven Display 1 Heat / 1 Cool

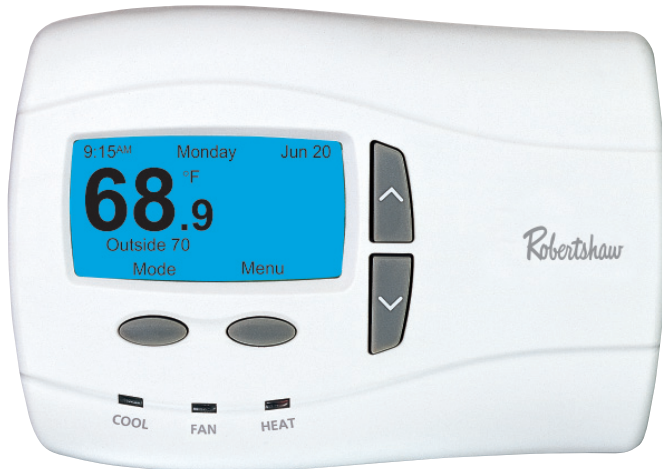

Programming Made Even Easier

Do you want to spend less time installing and setting up thermostats?

The new 9701i2 makes installation even easier with our new Setup Wizard. The Setup Wizard allows you to spend 50% less time setting up the thermostat over competitive models. Plus everything is in plain language so there are no complicated codes or button combinations to memorize.

We've also made programming even easier for your customers. Menus are easier to navigate. We've even added additional convenience features such as Automated Time adjustment for Daylight Saving Time, along with new indoor air quality reminders.

The new 9701i2 is so user friendly, it sets a higher standard in efficiency and simplicity for programmable thermostats. It is truly programming made even easier.

Robertshaw - *Simply the Right Choice™*

Features and Benefits

Would You Like To Run the Setup Wizard?

No Yes

Set-up Wizard

Helps speed through the installation process with step-by-step setup and programming instructions.

Select Language

English
Español
Français

Back Next

Trilingual Display Option

Set to your customers' language of choice – English, Spanish or French

Mon To Sun Program

		HEAT	COOL
Wake	6:00 AM	70	78
Morn	8:00 AM	62	65
Eve	5:00 PM	70	78
Night	10:00 PM	62	62
Exit		Select	

Convenient Displays

View a full day of programming at once for quick review or easy adjustment.

Tech Support

Model 9701i vX.X
ABC HEAT
555-1234
ROBERTSHAW
(800) 445-8299
Back

Contractor ID Feature

Set it yourself or custom order with your information pre loaded. Your name and phone number remind your customers when service is needed.

Daylight Saving Time Adjustment

Automatically adjusts to correct time regardless of seasonal changes.

Adjustable Backlighting

Choose to have backlighting on at all times or only when programming. You can also adjust the brightness and contrast for improved readability.

Time of Day Zoning

When coupled with a remote sensor (part #9020i), you can control the temperature in remote locations given different scheduled events.

Three Levels of Security

Secure protection against unwanted changes to the programming menus, temperature or set-up functions with your own 4-digit PIN.

Auto Changeover

Automatically adjusts between heating and cooling cycles to maintain optimal comfort.

Worry-Free Memory Storage

Even during power outages, the thermostat maintains set point and programmed parameters.

Adjustable Temperature Offset

Change the displayed temperature from the actual sensed temperature.

Adjustable Temperature Differential

Maintains optimal customer comfort.

Intermittent Fan

Maintains optimal air filtration and circulation with minimal energy use.

An ISO 9001 – 2008 Certified Company

California Title 24 Compliant



5 Year
Limited
Warranty

24V AC POWERED

Robertshaw®

9701i2 DELUXE PROGRAMMABLE THERMOSTAT

Terminal Designations

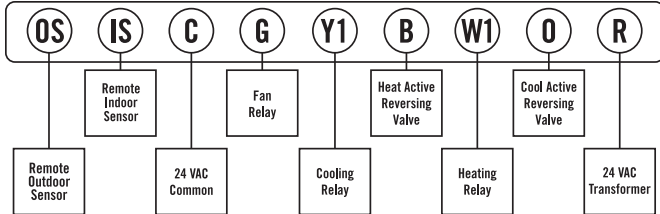

Technical Specifications

Electrical Rating	24 Volt AC (18-30 VAC) 1 amp maximum load per terminal (relay outputs) 3 amp total maximum load (all terminals combined)
Temperature Control Range	45°- 90°F (7°- 32°C)
Accuracy	+/-1.0°F (+/-0.5°C)
Power Source	24 VAC
Auto Changeover Deadband	Selectable 2° to 8°F
Temporary Temperature Override	3 hour maximum or next setpoint
Remote Sensor Capable	1 indoor and 1 outdoor sensor
System Configurations	Single-stage gas, oil or electric heating/cooling systems and single stage heat pump
Terminations	R, W1, Y1, B, O, G, C, IS, OS

Shipping Specifications

Indiv. Ctn. Dim.: 6.625" x 4.25" x 1.625"	Item 9020i and 9025i Remote Sensors
Master Ctn. Qty.: 6	Indiv. Ctn. Dim.: 2.625" x 1.5625" x 4.4375"
Master Ctn. Dim.: 9.25" x 5.625 x 7.5"	Master Ctn. Qty.: 6
Master Ctn. Cu. Ft.: .23	Master Ctn. Dim.: 5.625" x 5.125" x 5.125"
Master Ctn. Wt.: 3.5 lbs.	Master Ctn. Cu. Ft.: .09
Max. Pallet Qty.: 1260	Master Ctn. Wt.: .78 lbs.
Max. Pallet Wt.: 785 lbs.	

Replacement Chart

9701i2	
Braeburn®	5000
Honeywell	TH8110U1003
White-Rodgers	1F95-1271, 1F90-51, 1F90-71, 1F90-371, 1F97-51, 1F97-71, 1F97-371
Carrier	TC-PAC, TC-PHP, P274-1100, P374-1100, P474-1100
Lux	PSPA711

Verify specific application requirements before substitution.

Patent Information

This product is covered by one or more of the following U.S. patents. Foreign patent rights may be pending. 4967382, 5803357, 6502758, 7000849, D301207, D462940

invenSYS
Controls

191 E. North Avenue
Carol Stream Illinois 60188 USA
Customer Service Telephone 1.800.304.6563
Customer Service Facsimile 1.800.426.0804
HVACCustomerService@InvenSysControls.com

For Technical Service
Telephone 1.800.445.8299
Facsimile 1.630.260.7294
TechnicalService@InvenSysContrtols.com

InvenSys™, Robertshaw® and Simply the Right Choice™ are trademarks of InvenSys plc., its subsidiaries and/or affiliated companies. All other brands mentioned in this report may be the trademarks of their respective owners.

www.RobertshawTstats.com
www.InvenSysControls.com
©2009 InvenSys Controls 10/09 - 150-1978B



Optional Sensors:
9020i: REMOTE INDOOR
9025i: REMOTE OUTDOOR

Feature Comparison

	InvenSys i2-Series	Honeywell Vision Pro	Carrier Infinity	White-Rodgers 1F97-371
Menu Driven (Ease of Programming)	X			
Installation Wizard	X			
Displays Complete Program	X			
Adjustable Backlighting	X			
Cooling System Monitor	X			
Heating System Monitor	X			
Multi-Language	X			
1/2 Degree Resolution	X			
Time of Day Zoning	X			
5/2 Program	X			X
24 Hour Programming	X			X
7-Day Programming	X	X	X	
Large Display	X	X	X	
Adjustable Timed Override/Hold	X	X		
Automatic Daylight Saving Time Adjustment	X	X		
Adjustable Temperature Limits	X	X		
High/Low Balance Points	X	X		
LED Status Indicators	X	X		
Adjustable Differential	X	X		
Adjustable Compressor Short Cycle Protection	X	X		
Adjustable Residual Cooling	X	X		
Fossil Fuel Kit required on HP units	No	No	Yes	Yes
Battery Free Memory Retention	X		X	
Manual Override	X	X	X	X
Resume	X	X	X	X
Auto Changeover	X	X	X	X
Gas/Electric	X	X	X	X
Single Stage Heat Pump Compatible	X	X	X	X
Line Powered	X	X	X	X
Programmable Fan	X	X	X	X
Intermittent Fan	X		X	
°F and °C	X	X	X	X
12 or 24 Hour	X	X		X
Air Filter Monitor	X	X	X	X
Humidifier Pad Monitor	X	X	X	
UV Light Monitor	X	X	X	
Vacation Setting	X	X	X	X
O & B Terminals	X	X	Partial	X
Events per day	2, 4, 6	4	4	2, 4
Remote Outdoor Sensor	X	Combo	X	X
Remote Indoor Sensor	X		X	X
Energy Efficient Recovery	X	X	X	X
Pre-set Program	X	X	X	X
Hidden Service Level	X	X	X	
Security Key Pad	X			X
Temperature Recalibration	X	X	X	
Customizable Contractor ID	X			Factory Only

NOTE: Always keep the thermostat's vents clean and unobstructed.

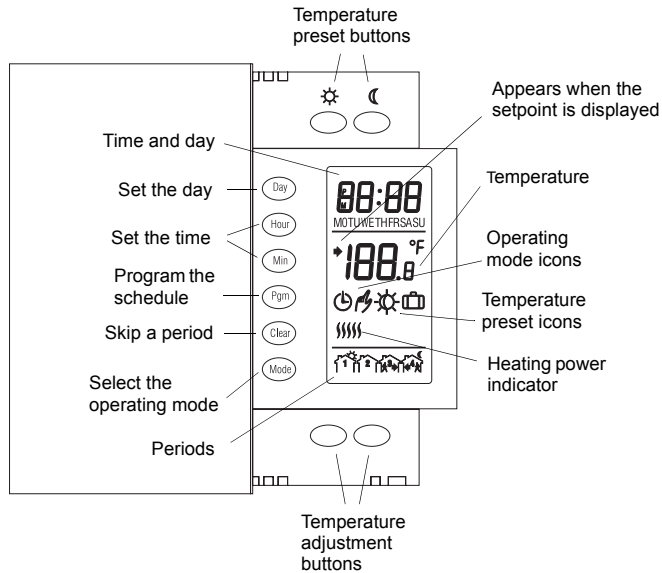

1 Description

This programmable thermostat can be used to control an electric heating system such as an electric baseboard heater, a radiant ceiling, a radiant floor, a convector, etc.

The thermostat cannot be used under the following conditions:

- The resistive load is greater than 16.7 A
- The resistive load is less than 2 A
- The system is driven by a contactor or relay (inductive load)
- The system is a central heating system

SUPPLIED PARTS:

- One (1) thermostat
- Two (2) 6-32 screws
- Two (2) solderless connectors

2 Installation

TURN OFF POWER TO THE HEATING SYSTEM AT THE MAIN POWER PANEL TO AVOID ELECTRICAL SHOCK.

THE INSTALLATION MUST BE PERFORMED BY AN ELECTRICIAN.

- ▶ All cables and connections must conform to the local electrical code.
- ▶ Special CO/ALR solderless connectors must be used when connecting with aluminum conductors.
- ▶ Install the thermostat onto an electrical box.
- ▶ Install the thermostat about 5 feet high, on an inside wall facing the heater.
- ▶ Avoid locations where there are air drafts (such as the top of a staircase or an air outlet), dead air spots (such as behind a door), or direct sunlight.
- ▶ Do not install the thermostat on a wall that conceals chimney or stove pipes.
- ▶ The thermostat wires are not polarized; either wire can be connected to the load or to the power supply.

1

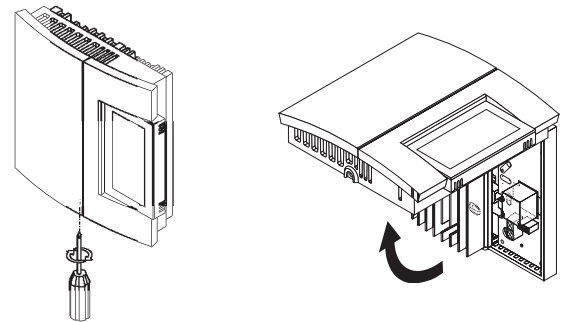

2 Connect the thermostat wires to the line wires and to the load wires using solderless connectors for copper wires.

2-wire installation

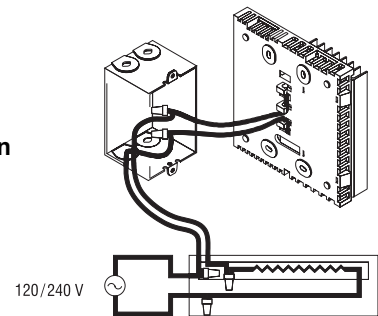

4-wire installation

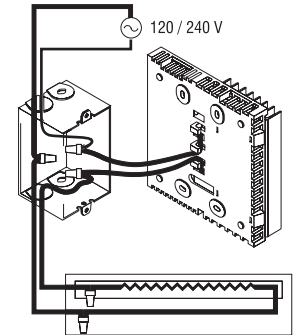

3 Push any excess wire back into the electrical box.

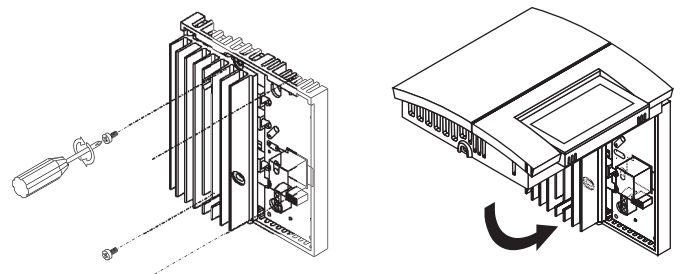

NOTE: If necessary, before re-installing the front component, configure the thermostat (see section 3).

4 Return power to heating system.

3 Configuration

The configuration switches are on the back of the thermostat. The factory settings are indicated by the gray cells in the following table.

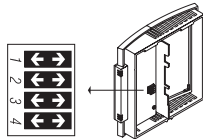

SW1	Early Start ^a	Off	On
SW2	Temperature / time format ^b	°C / 24-hour	°F / 12-hour
SW3	Cycle length ^c	15 seconds	15 minutes
SW4	Not used	-	-

- Early Start can be used in Automatic mode only. When this function is enabled, the thermostat calculates the optimal time to start heating in order to obtain the desired temperature by the set time. The thermostat re-assesses the start time daily based on the previous day's performance.
- If you change the temperature display format, the preset temperatures (☼, ☾ and ☰) will return to their default settings.
- 15-second cycles should be selected in most cases as it provides better temperature control. 15-minute cycles must be selected if you have a fan-equipped heater or if 15-second cycles causes light flickering (especially in rural regions).

4 Power-up

Upon power-up, the thermostat is in manual mode (☼) and displays the actual (ambient) temperature.

- Press the **Hour** and **Min** buttons to set the thermostat's clock.
- Press the **Day** button to set the day.

5 Temperature Setting

Setpoint

The thermostat normally displays the actual temperature. To view the setpoint, press the ▲ or ▼ button briefly. The setpoint will appear for the next 5 seconds.

To change the setpoint, press the ▲ or ▼ button until the desired temperature is displayed. To scroll faster, hold the button.

Using a preset temperature

The thermostat has 3 preset temperatures:

- ▶ Comfort temperature ☼
- ▶ Economy temperature ☾
- ▶ Vacation temperature ☰

Icon	Intended use	Factory setting
☼	Comfort (when at home)	21°C (70°F)
☾	Economy (when asleep or away from home)	16.5°C (62°F)
☰	Vacation (during prolonged absence)	10°C (50°F)

- To use the Comfort or Economy temperature, press the ☼ or ☾ button respectively. The corresponding icon will be displayed.
- To use the Vacation temperature, press both ☼ and ☾ buttons simultaneously. The ☰ icon will be displayed.

Storing a preset temperature

To store the Comfort or Economy temperature:

Set the desired temperature using the ▲ or ▼ button. Press and hold the appropriate button (☼ or ☾) for approximately 3 seconds until the corresponding icon is displayed. Press the **Mode** button.

To store the Vacation temperature:

Set the desired temperature using the ▲ or ▼ button. Press and hold both ☼ and ☾ buttons simultaneously for approximately 3 seconds until the ☰ icon is displayed. Press the **Mode** button.

6 Operating Modes

⌚ **Automatic** - The temperature is set according to the programmed schedule. To place the thermostat in this mode, press **Mode** until ⌚ is displayed. The icons of the current period and preset temperature are also displayed.

Temporary Bypass: If you modify the setpoint (by pressing the ▲, ▼, ☼ or ☾ button) when the thermostat is in automatic mode, the new setpoint will be used until the end of the current period. When the next period starts, the temperature set for that period becomes the new setpoint.

☼ **Manual** - The programmed schedule is not used. The temperature must be set manually. To place the thermostat in this mode:

- Press **Mode** until ☼ is displayed.
- Set the temperature using the ▲, ▼, ☼ or ☾ button.

7 Schedule

The schedule consists of 4 periods per day which represents a typical weekday. You can program the thermostat to skip the periods that do not apply to your situation. For example, you can skip periods 2 and 3 for the weekend.

Period	Description	Associated temperature preset
☼	Wake	☼
☾	Leave	☾
☼	Return	☼
☾	Sleep	☾

The Comfort (☼) temperature is used in periods 1 and 3 and the Economy (☾) temperature is used in periods 2 and 4. For example, when the period changes from 1 to 2, the setpoint automatically changes from Comfort setting (☼) to Economy setting (☾).

You can have a different program for each day of the week; i.e., each period can start at different time for each day of the week. The thermostat has been programmed with the following schedule.

Period	Setting	MO	TU	WE	TH	FR	SA	SU
☼	☼	6:00 AM	6:00 AM	6:00 AM	6:00 AM	6:00 AM	6:00 AM	6:00 AM
☾	☾	8:00 AM	8:00 AM	8:00 AM	8:00 AM	8:00 AM	--:--	--:--
☼	☼	6:00 PM	6:00 PM	6:00 PM	6:00 PM	6:00 PM	--:--	--:--
☾	☾	10:00 PM	10:00 PM	10:00 PM	10:00 PM	10:00 PM	10:00 PM	10:00 PM

To modify the schedule:

- Press **Pgm** to access the programming mode. Period 1 is selected.
- Press **Day** to select the day to program (hold for 3 seconds to select the entire week).
- Press **Hour** and **Min** to set the start time of the selected period, or press **Clear** if you want to skip the period (--:-- is displayed).
- Press **Pgm** to select another period, or press **Day** to select another day. Then repeat step 3.

5 Press **Mode** to exit the programming mode.

NOTE: If no button is pressed for 60 seconds, the thermostat will automatically exit the programming mode.

8 Power Outage

During a power outage, the settings are stored in memory. However, only the thermostat's clock must be re-adjusted if the power failure lasts more than 2 hours. When power comes back, the thermostat will return to the operating mode that was active prior to the power failure.

9 Troubleshooting

PROBLEM	SOLUTIONS
Thermostat is hot.	This condition is normal. Under normal operation, the thermostat housing can reach a temperature between 35°C (95°F) and 40°C (104°F).
Heater is always On.	The thermostat has not been correctly wired.
Thermostat indicates that heating is On, but the heater is not On.	The thermostat has not been correctly wired.
Wrong temperature is displayed.	The thermostat is exposed to air draft. Eliminate the draft. The sticker on the thermostat's screen has not been removed.
Wrong time is displayed.	The thermostat was without power for more than 2 hours.
Temperature does not change according to the programmed schedule.	Check that the thermostat is in Automatic mode. Check the schedule and clock settings.
Display disappears and reappears after a few minutes.	The thermal protection device on the heater is open. This can happen after a power failure or if the heater is obstructed by furniture or curtains.
Display looks faded when heating is activated	The heating system is less than the required minimum load. This thermostat cannot be used below that rating.

10 Technical Specifications

Power: 120/240 VAC, 50/60 Hz

Minimum load: 2 A (resistive only)
500 W @ 240 VAC
250 W @ 120 VAC

Maximum load: 16.7 A (resistive only)
2000 W @ 120 VAC
4000 W @ 240 VAC

Display range: 0°C to 60°C (32°F to 140°F)

Display resolution: 0.5°C (1°F)

Setpoint range: 5°C to 30°C (40°F to 86°F)

Setpoint interval: 0.5°C (1°F)

Storage: -20°C to 50°C (-4°F to 120°F)

Approval: c UL us

Warranty

Aube warrants this product, excluding battery, to be free from defects in the workmanship or materials, under normal use and service, for a period of three (3) years from the date of purchase by the consumer. If at any time during the warranty period the product is determined to be defective or malfunctions, Aube shall repair or replace it (at Aube's option).

If the product is defective,

- (i) return it, with a bill of sale or other dated proof of purchase, to the place from which you purchased it, or
- (ii) contact Aube. Aube will make the determination whether the product should be returned, or whether a replacement product can be sent to you.

This warranty does not cover removal or reinstallation costs. This warranty shall not apply if it is shown by Aube that the defect or malfunction was caused by damage which occurred while the product was in the possession of a consumer.

Aube's sole responsibility shall be to repair or replace the product within the terms stated above. AUBE SHALL NOT BE LIABLE FOR ANY LOSS OR DAMAGE OF ANY KIND, INCLUDING ANY INCIDENTAL OR CONSEQUENTIAL DAMAGES RESULTING, DIRECTLY OR INDIRECTLY, FROM ANY BREACH OF ANY WARRANTY, EXPRESS OR IMPLIED, OR ANY OTHER FAILURE OF THIS PRODUCT. Some provinces and states do not allow the exclusion or limitation of incidental or consequential damages, so this limitation may not apply to you.

THIS WARRANTY IS THE ONLY EXPRESS WARRANTY AUBE MAKES ON THIS PRODUCT. THE DURATION OF ANY IMPLIED WARRANTIES, INCLUDING THE WARRANTIES OF MERCHANTABILITY AND FITNESS FOR A PARTICULAR PURPOSE, IS HEREBY LIMITED TO THE THREE-YEAR DURATION OF THIS WARRANTY. Some provinces and states do not allow limitations on how long an implied warranty lasts, so the above limitation may not apply to you.

This warranty gives you specific legal rights, and you may have other rights which vary from province or state to another.

Customer Assistance

If you have any questions about the product installation or operation, or concerning the warranty, contact us at:

705 Montrichard
Saint-Jean-sur-Richelieu, Quebec
J2X 5K8
Canada
Tel.: (450) 358-4600
Toll-free: 1-800-831-AUBE
Fax: (450) 358-4650
Email: aube.service@honeywell.com

For more information on our products, go to
www.aubetech.com



As an ENERGY STAR® partner, Aube Technologies has determined that this product meets the ENERGY STAR guidelines for energy efficiency.



LED T8 | T12

Notify Me when Available

[Large Project? Click here to get a volume quote.](#)



DESCRIPTION

SPECIFICATIONS

REVIEWS

EarthLED Total Product Insight

PERFORMANCE SPECIFICATIONS

REPLACEMENT FOR:	T8 OR T12 4 FOOT FLUORESCENT TUBE
BRIGHTNESS (LUMENS):	2000
COLOR TEMPERATURE:	4000K 5000K
COLOR ACCURACY (CRI):	80
DIMENSIONS	1.02" X 47.2"
POWER CONSUMPTION:	18 WATTS
VOLTAGE:	120-277 VOLTS
DIMMABLE:	NO

DIMENSIONS / ADDITIONAL DATA

CERTIFICATIONS:	UL, DESIGNLIGHTS (DLC)
PRODUCT/ORDER CODE:	4000K - 18WT8P-4F-40K-BYP 5000K - 18WT8P-4F-50K-BYP

LIFESPAN / COST TO RUN

PROJECTED LIFE: @3 HRS/DAY	50,000 HRS
YEARLY ENERGY COST: 3 HRS/DAY @ .11 KWH	\$2.17

WARRANTY

5 YEAR THINKLUX LIGHTING LIMITED WARRANTY
EARTHLED PRODUCT PROTECTION PLAN IS AVAILABLE